

Door Surrounds

Required for Installation: Electric drill, 1/4" drill bit, saw, screws, shutter fasteners. (1/4" carbide drill bit is required for stucco, hardboard, fiber cement, brick, or masonry.)

Note: The illustrations contained in these instructions use a 9" Header and Base for examples. A 6" Header and Base can be used just as easily.

The siding has been removed from the illustrations for clarity.

Step 1

Measure the height of the door. This includes any brick mold or trim that may be around the door. Record this as dimension 'A'.

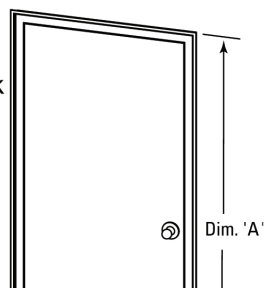

Step 2

Assemble the pilasters to the pilaster bases. Cut the pilaster assembly from the top so that its finished length is Dim. 'A' minus 1/2". To achieve this, use the following formula: 96" (the length of the pilaster) minus Dim. 'A' minus 1/2" equals Dim. 'B'. Measure and cut Dim. 'B' from the top of both pilasters. See figure at right. Be sure the pilasters are oriented in the correct position before cutting. The flat side of the pilaster goes against the door. If Dim. 'B' is greater than 10", cut the remaining material off the bottom of the pilaster.

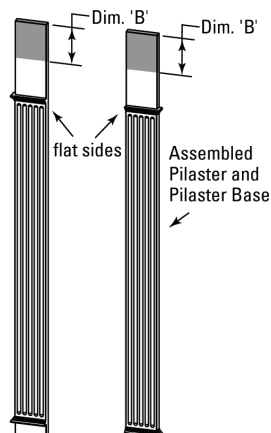

Step 3

Unsnap the assembly and position the Pilaster Base 1/8" away from the sides of the door and 1/4" up from the bottom of the door. This should leave it 1/4" short from the top of the door.

Step 4

Place a screw (not a shutter fastener) in the center hole of the Pilaster Base (not in a slot). This insures that the expansion and contraction will be a minimum at the top and bottom.

Step 5

Place the remaining screws in the slots or drill 1/4" holes 2 1/2" deep into the wall to accept the shutter fasteners. Use the shutter fasteners only in the round holes molded into the raised areas of the Pilaster Base. Do this for both sides of the door. The screws should be centered in the slot and not over tightened. The Pilaster Base must be able to expand and contract with changes in temperature.

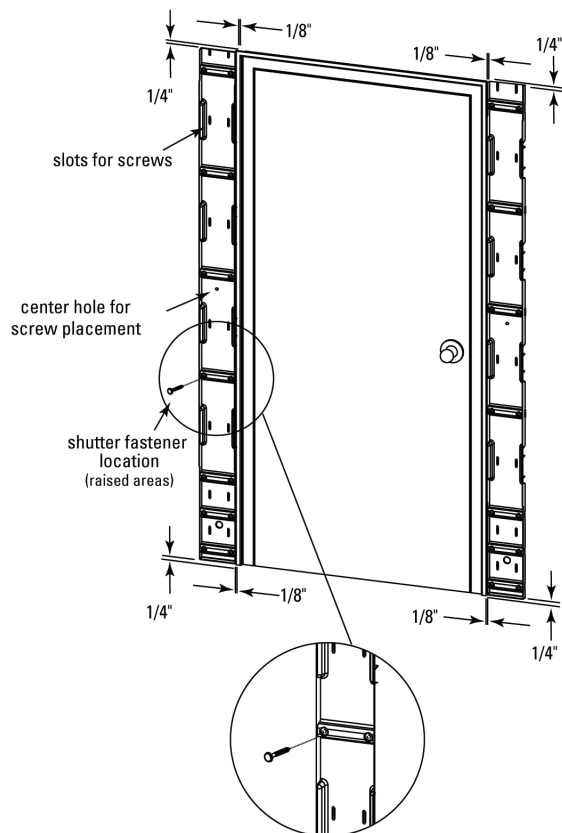

Door Surrounds, contd.

Step 6

Snap the Pilasters over the Pilaster Bases. Be sure the locks of the pilaster are fully engaged.

Mounting the Header

Step 7

Mark the center of the door with a vertical line.

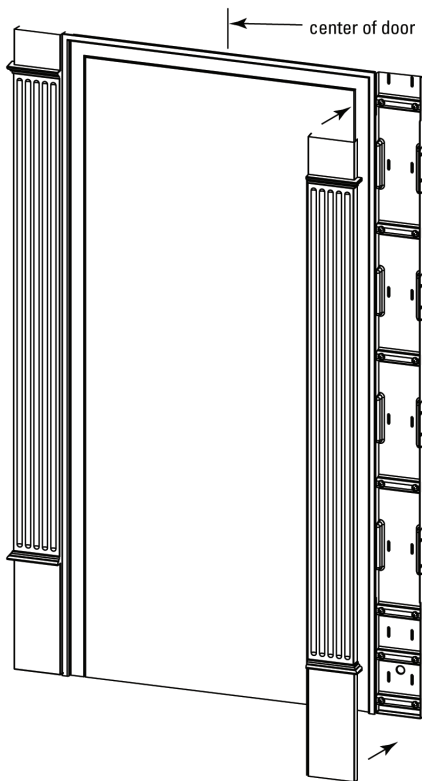

Step 8

Measure the distance between the outside edges of the Pilasters and record this as Dim. 'D'.

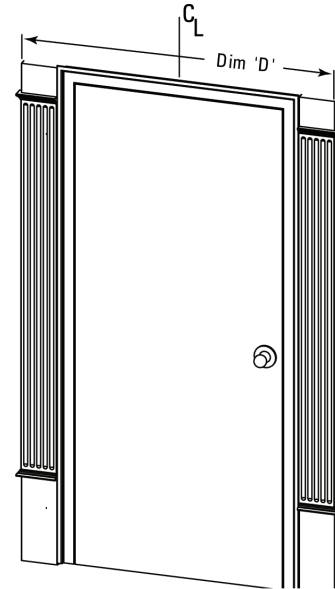

Note: There are different methods to place the header on the door.

Method A

If you want your installation to look like Method 'A', you will need to add $1\frac{1}{4}$ " to Dim. 'D'. This will allow the Header to be flush with the Transition Top when it's installed.

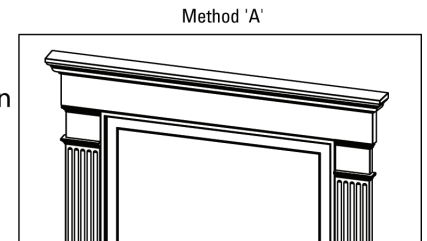

Method B

If you want your installation to look like Method 'B', you will need to add the amount of overhang you want. Be sure to multiply the amount of overhang by 2 when adding. You want the overhang on both sides of the door.

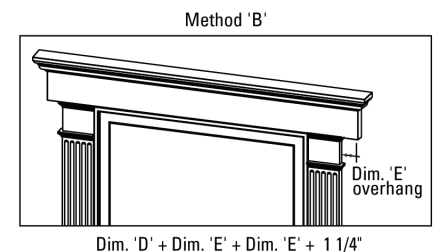

Note: If you have ordered a custom cut or standard size header in the exact size needed, go to step 14.

Door Surrounds, contd.

Step 9

With the Header and Header Base assembled, mark the center line (CL) of the assembly.

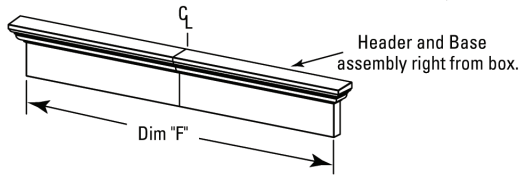

Step 10

Next, subtract the dimension from Method A or B on page 15 from Dim. 'F' and divide the result by 2. This will give you Dim 'G'.

$$\frac{\text{Dim. 'F' - A or B Dim.}}{2} = \text{Dim. 'G'}$$

Step 11

Transfer Dim. 'G' to the Header Assembly. Dim. 'G' will be transferred 2 times; once on each side of the center line.

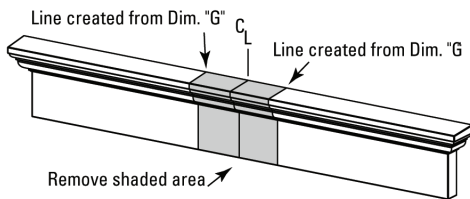

Step 12

Cut the Header and Header Base assembly at the lines created by Dim. 'G'.

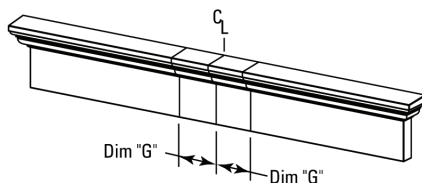

Step 13

Once the Header has been cut to the correct length, disengage the locking tabs and remove the header from the Header Base. To release the locks, start at the open end of the cut Header Assembly and pull the wall of the Header away from the Header Base. Continue this process, working your way to the end of the cut Header Assembly.

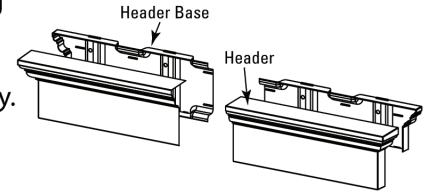

Step 14

Align the Center Line (CL) of the door to the cut edges of the Header Base. Leave approximately an 1/8" gap between the bottom of the Header Base and the top of the door. This will give the Header clearance when snapped into place. When the Header base is properly located, fasten it into place. The preferred method of attaching the base to the house is to use the shutter fasteners that are enclosed with the kit. In order to install the shutter fasteners, 1/4" holes must be drilled 3" deep into the wall. Use the shutter fasteners only in the round holes molded into the raised areas of the Header Base. Space the shutter fasteners accordingly along the Header Base.

Another method is to use screws. Use the elongated slot in the base and attach the base to the house using the screws provided with the kit.

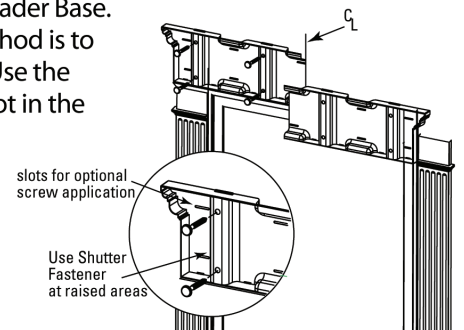

Be sure not to fasten the screws too tightly to allow for expansion and contraction.

Step 15

Place the Transition Top pieces on the Header in the approximate locations of the Pilasters. Clip them to the header using the clips provided. Use two clips per Transition Top.

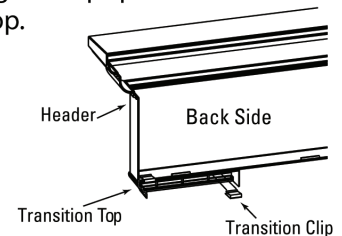

Door Surrounds, contd.

Step 16

Snap the Header over the Header Base. At this point you may have to reposition the Transition Top pieces so they line up correctly with the Pilasters.

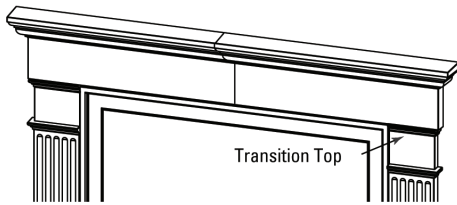

Installation of Keystone

If you are installing a classic dentil profile header, and the dentil teeth land on the sides of the keystone, it will need to be trimmed as shown below to properly snap in place.

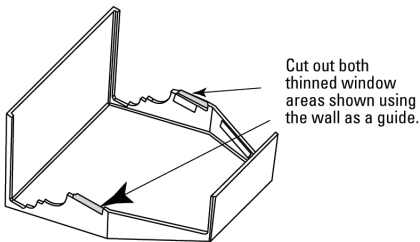

Step 17

Center the Keystone Base over the Header. The bottom of the Keystone Base and the bottom of the Header should be flush. Screw the Keystone Base into place using the enclosed screws.

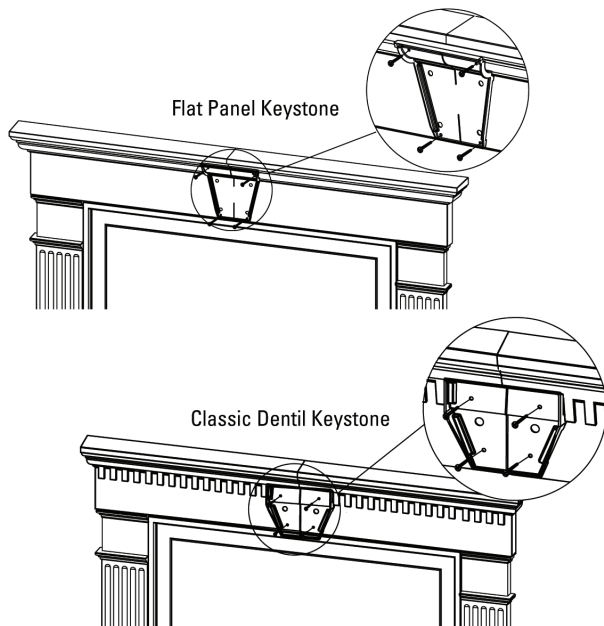

Step 18

Snap the Keystone over the Keystone Base. Be sure the lock tabs engage.

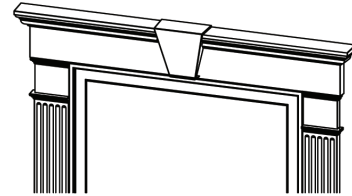

Step 19

The back of the Bottom Corner Base has text to show the correct orientation for the left and right side of the door. Line up the bottom of the Bottom Corner Base with the bottom of the Pilaster. Screw the Corner Base to the Pilaster using the elongated screw slots for proper screw placement.

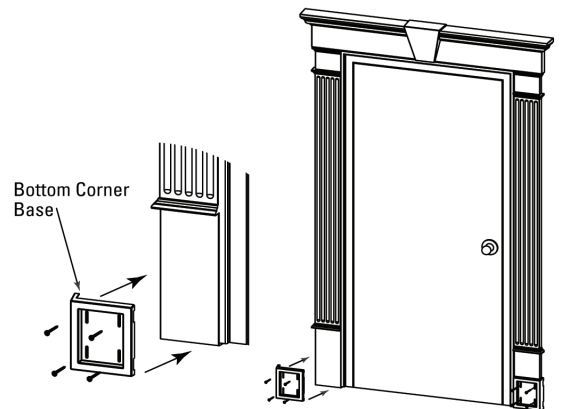

Step 20

Once the Bottom Corner Base has been securely fastened into place, snap the Bottom Corner over the Bottom Corner Base. Repeat the procedure for the other side of the door.

